

# Thermit Welding Process



## Amiable Impex

understands your values





## About Us !

**Amiable Impex are the Manufacturer for Copper Bonded Rod and Importer, Supplier and Distributor of Thermit Welding Powder and Accessories.** We provide high quality Thermit Welding Powder at reasonable rate with quickest lead time and fast response time.

### **Amiable Impex was formed by**

- 1) Mr. Ujjwal Shah (Having Experience of more than 15 years in Electrical Markets) and**
- 2) Mr. Maulik Shah (B.Com, M.com, PGDBM, PGDFM, MBA)**

Amiable Impex was founded with the goal of being at the forefront in the Electrical Metal Industry in both India and overseas for Copper Bonded Earth Rods and Thermit Welding Powder and Accessories. Since our foundation, the company has grown through continuous development. As a company, **Amiable** always strives to set its own agenda, rather than pursuing the business as a follower of existing market leader. Our Style of work is unique which always suits our Customer. We believe in giving Quality Product in Quality Service at Good price.

Amiable Impex endeavour to be a "more dynamic and competitive company" in order to respond appropriately to increasingly sophisticated and diverse customer requirements, and to provide superior value-added products through our innovation. We have very actively engaged in R&D activities to further improve of our product reliability and performance.

### **Our vision**

We have set the four pillars of our vision which set out the long term direction for our company Amiable Impex where we want to go and how we are going to get there:

- We work to create a better future every day.
- We help our customers feel good, have good and get more out of life with our brands and services that are good for them and good for others.
- Whilst the company has ambitious plans for the future for its product range and its manufacturing abilities, our greatest objective will always be to maintain the highest level of quality assurance & service to the customer.
- We will develop new ways of doing business with the aim of doubling the size of our company while reducing our environmental impact.

### **Purpose & principles**

The secret of our success is sincerity and the passion towards everyone we work with, the communities we touch, and the environment on which we have an impact. We understands our Customers Values"

### **Always working with integrity**

Conducting our operations with integrity and with respect for the many people, organizations and environments our business touches has always been at the heart of our customer's responsibility and Satisfaction towards our quality assurance.

### **Positive impact**

we aim to make a positive impact in many ways: through our brands, our commercial operations and relationships, through voluntary contributions, and through the various other ways in which we engage with our international and local customers.

### **Continuous commitment**

we're also committed to continuously improving the way we manage our environmental impacts and are working towards our longer-term goal of developing a sustainable business and higher customer satisfaction through our unmatched service.

### **Setting out our aspirations**

our purpose sets out our aspirations in running our business. It's underpinned by our code of business Principles which describes the operational standards that everyone at AMAIBLE follows, wherever they are in the world.

### **Future possibilities**

we are proud of our reputation and Brand image through our continuous innovation and renovation.

## **Some of Our Esteemed Customers**



**LARSEN & TOUBRO**



S. no.	THERMIT WELDING POWDER INDEX	Page no.
01	Thermit Welding Process	05
02	Tools Required for Thermit Welding Process	06
03	Thermit Welding Operation Process	08
04	General Safety Instructions	10
05	Mould Selection Chart	11
06	Cable to Cable Connections Thermit Welding Joints (CTC)	11
07	Cable to Ground Rod Connections Thermit Welding Joints (CGRC)	12
08	Cable to Lug / Tape Connection Thermit Welding Joints (CLTC)	13
09	Cable to Steel Connections Thermit Welding Joints (CTS)	14
10	Steel to Lug / Tape Connections Thermit Welding Joints (SLTC)	15
11	Steel to Rod / Stud Connections Thermit Welding Powder Joints (SRSC)	15
12	Ground Rod to Ground Rod Connections Thermit Welding Joints (GRGR)	16
13	Ground Rod to Tape Connections Thermit Welding Powder Joints (GRTC)	16
14	Cable to Re-Bar Connection Thermit Welding Joints (CREC)	17
15	Tape to Re-Bar Connection Thermit Welding Powder Joints (TREC)	18
16	Re-Bar to Re-Bar Connection Thermit Welding Joints (RERE)	18
17	Rod to Re-Bar Connection Thermit Welding Powder Joints (RORE)	18
18	Tape to Tape Connection Thermit Welding Powder Joints (TTC)	19

## THERMIT WELDING POWDER PROCESS

Thermit Welding Powder, also known as Thermit bonding and Thermit welding is a welding process for joining two electrical conductors that employs superheated copper alloy to permanently join the conductors. The process employs an Thermit reaction of a copper Thermit composition to heat the copper, and requires no external source of heat or current. The chemical reaction that produces the heat is an aluminothermic reaction between aluminum powder and a metal oxide.

The reaction reaches very high temperatures, depending on The metal oxide used. The reactants are usually supplied In the form of powders, with the reaction triggered using a Spark from a flint lighter. The activation energy for this reaction Is very high however, and initiation requires either the use of A “booster” material such as powdered magnesium metal or a Very hot flame source. The aluminum oxide slag that it produces Is discarded.

When welding copper conductors, the process employs a Semi-permanent graphite crucible mould, in which the molten Copper, produced by the reaction, flows through the mould and over and around the conductors to be welded, forming an Electrically conductive weld between them. When the copper cools, the mould is either broken off or left in place. Alternatively, hand-held graphite crucibles can be used. The advantages of these crucibles include portability, lower cost (because they can be reused), and flexibility, especially in field applications.

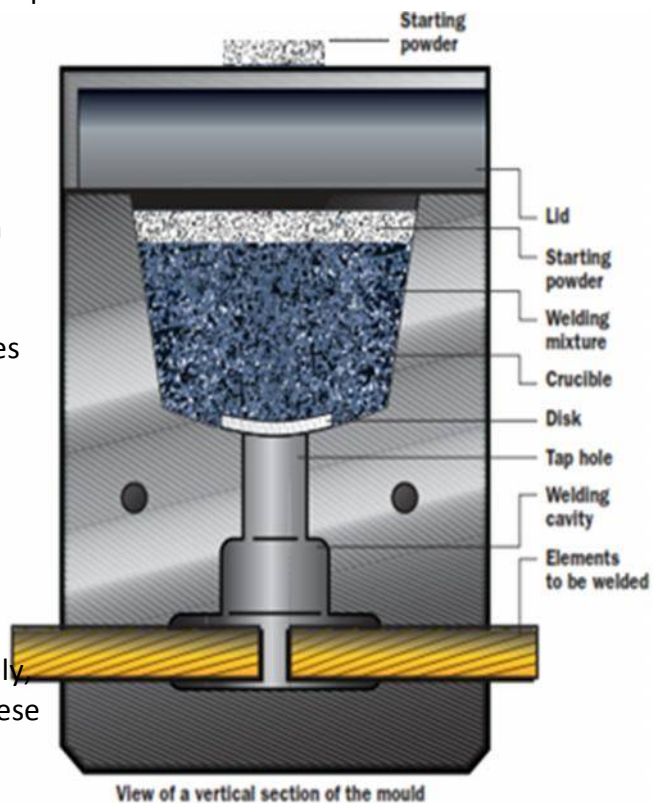

The weld formed has higher mechanical strength than other forms of weld, and excellent corrosion resistance. It is also highly stable when subject to repeated short-circuit pulses, and does not suffer from increased electrical resistance over the lifetime of the installation. However, the process is costly relative to other welding processes, requires a supply of replaceable moulds, suffers from a lack of repeatability, and can be impeded by wet conditions or bad weather (when performed outdoors).

### FEATURES

- It has a superior electrical conductivity than the conductors themselves.
- It does not corrode oxide or degrade with time and is resistant to galvanic coupling.
- It is able to withstand repeated electrical discharges.
- It never increases its resistance.
- It has higher mechanical and squeezing resistance than the conductors themselves.
- It offers a permanent welding and a low resistance connection, essential for achieving longwearing and trustworthy results in earthings
- It guarantees the most common connections not only between copper cables but also for welding tapes and metallic pieces made of brass, stainless steel, and copper coated steel earth rods.



# TOOLS REQUIRED FOR THERMIT WELDING POWDER PROCESS

## 1) Graphite Mould

Graphite mould is made of high quality graphite suitable for high quality welding work and can be used for several times.

Following are the advantages.

1. A smooth metal connection that will not loosen or corrode.
2. It is not affected by high current surge or over current.
3. No need for the external welding machine.
4. Use only lightweight and cheap equipment.

When making a copper wire connection of Ground rod or other metal connection, place the weld powder into the graphite mould. Just ignite to start the welding process. The result will be clean and smooth connection surface. It is also applicable for other metal such as: Iron, Galvanized Steel, Railway track, Cast Iron, Bronze, and Brass. It can be used in various applications to have the certainly good connections in work. Such as Lightning and Surge Protection, Grounding in Electrical Work, Railway Construction, Cathodic Protection. **The connection mould is designed to last for an average of 60 to 100 connections.** This will vary according to the care given the mould during use. We recommend not using Mould for more than 60 to 70 Connection because the Weld cavity Size increases after every joint, eventually making the Weld Cavity shape improper.



## 2) Mould Handle Clamp (Universal)

For most connections involving lugs, cable or rectangular bus, Thermit handle clamps are used. These will fit 90% of all standard Thermit molds. **Normally we recommend one Handle for every two moulds**



## 3) Steel Metal Disk

Steel discs are very important. The disc acts timing device to allow the welding powder to heat to proper temperature, the disc away allowing the molten copper to a point where it would weld metal to enter the weld gravity before ignition. **One Metal is must for every shot**

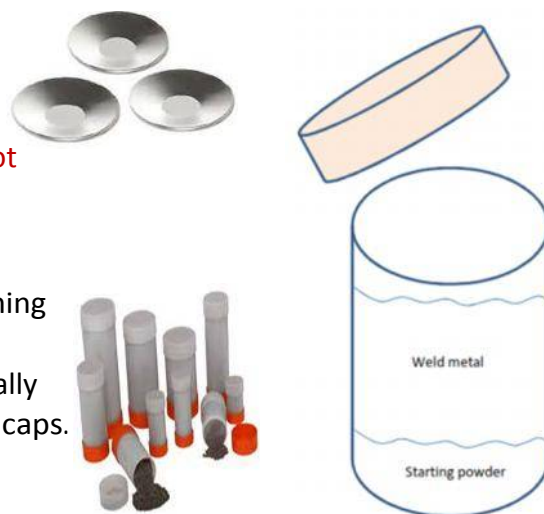

## 4) Thermit Welding Powder

Thermit Welding Powder is the most reliable and consistently-performing weld metal available with us. Quality validation steps are taken for every lot we produce. Upon final acceptance, our weld metal is specially packaged in moisture-resistant plastic cartridges with special closure caps. Then the cartridges and required metal discs are packaged in moisture-resistant boxes. All sizes of weld metal are available.

**Standards Size Packing available are – 50 Grams, 100 Grams, 125 Grams 150 Grams, 200 Grams, 250 Grams, 1 Kilogram**

**Our standard packing for welding powder is the following - Firstly welding powder is in the tube and**



1.1

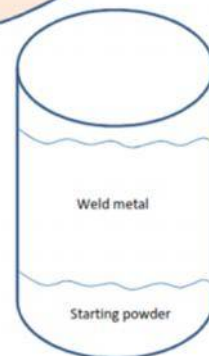

1.2

starting powder / Ignite Powder is in tube at the bottom of welding powder as shown in diagram 1.2.

## 5) Ignite Powder (Starting Powder)

Ignite Powder also known as Starting Powder is required and is must. Pour little Starting Powder on the Mould followed by the Thermit Welding powder and again pour it little on the Top Side of Mould. Ignite starting powder with a spark gun.



This resulting Thermit reaction reduces the weld powder to molten copper alloy. The molten copper alloy melts the retaining disc and flows into the weld cavity where it partially melts the conductors. **Ignite Powder of 5 grams is sufficient for this Process.**

## 6) Gloves

Gloves is required for safety purpose as the Thermit Welding Powder melts at more than 1400 degree Celcius.



## 7) Flint Gun

It is designed with the advantages of safety and convenience. It is used to ignite Starting Powder in order to result in Thermit reaction.

**We recommend one Flint Gun for every 100 Shots**



## 8) Brush (Soft and Hard)

Two Brush Required:

- 1) Soft Brush – Its used to Clean Mould Weld Cavity because its shape is very sensitive and there should not be any damage while using Brush, so we recommend to use Soft Brush to Clean Mould Weld Cavity
- 2) Hard Brush – Its used to clean other section of Mould

**We recommend a Pair of Brush for 50 Connection**



## 9) Slag Removal Tool

It is used to remove the metal Scrap from Mould



## 10) File Card

It is used to clean the objects to be welded



## 11) Sealing Compound

Sealing Compound is used to fill the gap on the mould where the conductor is passing.



## THERMIT WELDING OPERATION PROCESS

The Thermit Welding process is a method of making electrical connections of copper-to-copper or copper-to-steel in which no outside source of heat or power is required. In this process, conductors are prepared, placed in a purpose designed graphite mould, and Thermitally welded to produce a permanent molecularly bonded electrical connection. The steps outlined below are a general demonstration of a typical welded connection. These basic steps are used for all electrical connections. Be sure to read and follow the instructions included with every mold before making a connection.

### STEP - 1:

Always wear protective safety glasses and gloves while working with Thermit Welding Powder products.

### STEP - 2:

Gather all the proper material and equipment/accessories for the type of connection you are making. The typical Weld system requires a graphite mold, handle clamp, welding material, natural bristle brush for mold cleaning, wire brush for cleaning/preparing conductors, flint igniter, and propane torch. Check to ensure the graphite mold is not worn or broken, which could cause leakage of molten weld metal.



### STEP - 3:

Slide the handle clamp into the pre-drilled holes with the proper orientation for the thumbscrews.

### STEP - 4:

Tighten the clamp thumbscrews onto the mould.

### STEP - 5:

Close the grips to tightly lock the mold. Make adjustments to tighten/loosen the handle clamp.

### STEP - 6:

The material to be welded (cable, rod, tape) must be clean and dry using the brush included in the set of accessories. Thus the oxide layer and superficial impurity is eliminated. Given that the graphite mould also absorbs moisture, this should be removed by preheating with a gas welding torch to avoid a porous welding. After the first welding is done, it is not necessary to re-heat the mould if the next welding is done within 15 minutes as it conserves the previously generated heat.



**STEP - 7:**

Place the conductors in the mould and close the handle clamps to avoid material leakages during the reaction.

**Please Note – If there is even a minor gap between the two Conductors, apply Sealing Compound at the places where the conductors is passing out else at the time of Welding, the Powder will spread out as a flame resulting in improper joint**

**STEP - 8:**

Obstruct the tap hole with the metallic disk.

**STEP - 9:**

Empty the contents of the welding mixture package.

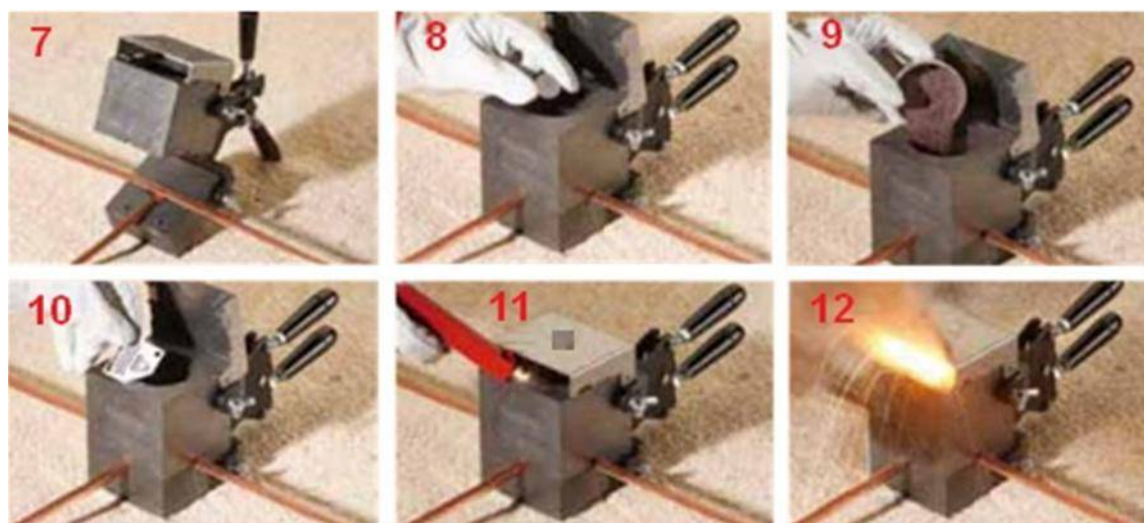

**STEP - 10:** Empty 50% of the starting powder above Thermit Welding Powder (**Don't Mix, just scatter**) and than Close the Mould Mouth and than the rest 50% Starting Powder, Sprinkle it on the Mould Mouth nearby the small hole given on the top of the Mould Mouth.

**STEP - 11:** Ignite the starting powder extended on the top/side of the mould using the flint igniters.

**STEP - 12:** Once started, the reaction will take 3-4 seconds during which it is recommended to stand clear of the mould.

**STEP - 13:**

After at least 2 minutes of the bonding, open the mould by undoing the handle grip. Remove the mould from the joint and clean the joint for any slag. Once open, clean the slag sticking to the mould with the relevant tool and clean the cavities. The mould will be ready now to use again without having to reheat it as it is already warm.



**Note:**

In Normal case minimum two moulds should be used on site to keep the process continue while one mould is cooled and cleaned after firing, the other should be used. The task should be undertaken very peacefully and one should not hurry.

## GENERAL & SAFETY INSTRUCTIONS:

- A. Only equipment and materials should be used to make connections.
- B. Do not connect items except as detailed in instruction sheets. Failure to comply with these instructions may result in improper and unsafe connections, damage to items being welded or even injury to body or property damage.
- C. Do not use worn or broken equipment which could cause leakage. Sealing compound should be used in case of fine leakages.
- D. When using Weld do not use welding material package if damaged or not fully intact.
- E. Make connections in conformance with instructions and all governing codes.
- F. Personnel should be properly trained and must wear safety glasses and gloves.
- G. Avoid contact with hot materials.
- H. Advise nearby personnel to stand at least 7 to 10 Foot away of welding operations site.
- I. Remove or protect the inflammable material from the operation site to safeguard against fire hazards.
- J. Provide adequate ventilation to the work area.
- K. Do not smoke when handling starting material.
- L. Avoid direct eye contact with “flash” of light from ignition of starting material.
- F. Welding material is an Thermit mixture and reacts to produce hot molten material with temperatures in excess of 1400°C (2500°F) and a localized release of smoke. Ignition temperatures are in excess of 900°C (1650°F) for welding material. **These materials are not explosive.**
- G. Adhering to the welding procedures will minimize risk of burns and fire caused by hot molten material spillage. In case of fire, use of water or CO<sub>2</sub> will aid in control of burning containers. Large quantities of water will aid in controlling a fire should the Thermit materials become involved. Water should be applied from a distance.
- H. All governing codes and regulations and those required by the job site must be observed. Always use appropriate safety equipment such as eye protection, hard hat, and gloves as appropriate to the application.

## WARNING :





1. Products shall be installed and used only as indicated in product instruction sheets.
2. Products must never be used for a purpose other than the purpose for which they were designed or in a manner that exceeds specified load ratings.
3. All instructions must be completely followed to ensure proper and safe installation and performance.
4. Improper installation, misuse, misapplication or other failure to comply with instructions and warnings may cause bad weld joint, property damage or even serious badly injuries.

## MAINTENANCE & STORAGE INSTRUCTIONS:

1. Mould is usually good for 50 - 60 connections in field conditions.
2. The equipment is fragile and should be handled carefully while in use.
3. Cleaning of moulds should be done using appropriate brush / tool after the mould is reasonably cool after a weld process. Avoid hot mould cleaning.
4. Cavity cleaning should be carefully done to avoid damages / chipping.
5. On completion of task, mould should be well cleaned from inside and from outside using soft cloth. It should be properly wrapped in Bubble Plastic Packing while storing it.
6. The moulds and the weld powder should always be stored in cool & dry places.
7. All tools and accessories must be cleaned before storing to safe reuse.





## Mould Selection Chart

### 1) Cable to Cable Connections Thermit Welding Joints (CTC)



























CTC - 1 	CTC - 2 	CTC - 3 	CTC - 4 	CTC - 5 
CTC - 6 	CTC - 7 	CTC - 11 	CTC - 13 	CTC - 14 
CTC - 15 	CTC - 16 	CTC - 17 	CTC - 18 	CTC - 19 
CTC - 20 	CTC - 21 	CTC - 23 	CTC - 24 	CTC - 25 
CTC - 26 	CTC - 27 	CTC - 28 	CTC - 29 	CTC - 30 
CTC - 31 	CTC - 33 	CTC - 34 	CTC - 35 	CTC - 36 
CTC - 37 	CTC - 38 	CTC - 39 	CTC - 40 	CTC - 41 



## 2) Cable to Ground Rod Connections Thermit Welding Joints (CGRC)











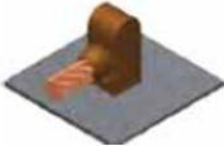
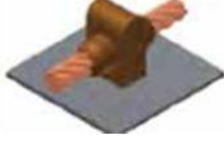







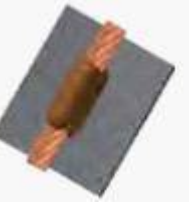





CGRC – 1 	CGRC – 2 	CGRC – 3 	CGRC – 4 	CGRC – 5 
CGRC – 6 	CGRC – 7 	CGRC – 8 	CGRC – 9 	CGRC – 11 
CGRC – 12 	CGRC – 13 	CGRC – 14 	CGRC – 15 	CGRC – 16 
CGRC – 17 	CGRC – 18 	CGRC – 19 	CGRC – 20 	CGRC – 21 
CGRC – 22 	CGRC – 23 	CGRC – 24 	CGRC – 25 	CGRC – 26 
CGRC – 31 	CGRC – 33 	CGRC – 34 	CGRC – 35 	CGRC – 36 
CGRC – 37 	CGRC – 38 	CGRC – 39 	CGRC – 40 	CGRC – 41 

### 3) Cable to Lug / Tape Connection Thermit Welding Joints (CLTC)

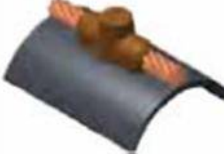















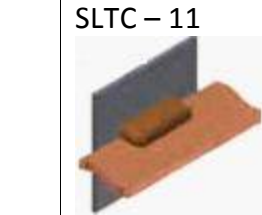

CLTC - 1 	CLTC - 2 	CLTC - 3 	CLTC - 4 	CLTC - 5 
CLTC - 8 	CLTC - 9 s 	CLTC - 11 	CLTC - 12 	CLTC - 13 
CLTC - 14 	CLTC - 15 	CLTC - 16 	CLTC - 17 	CLTC - 18 
CLTC - 19 	CLTC - 20 	CLTC - 21 	CLTC - 22 	CLTC - 23 
CLTC - 24 	CLTC - 25 	CLTC - 26 	CLTC - 27 	CLTC - 28 
CLTC - 29 	CLTC - 30 	CLTC - 31 	CLTC - 32 	CLTC - 33 
CLTC - 34 	CLTC - 35 	CLTC - 36 	CLTC - 37 	CLTC - 38 











#### 4) Cable to Steel Connections Thermit Welding Joints (CTS)

CTS - 1 	CTS - 2 	CTS - 3 	CTS - 4 	CTS - 6 
CTS - 7 	CTS - 8 	CTS - 9 	CTS - 12 	CTS - 13 
CTS - 14 	CTS - 15 	CTS - 16 	CTS - 22 	CTS - 23 
CTS - 24 	CTS - 25 	CTS - 26 	CTS - 27 	CTS - 31 
CTS - 32 	CTS - 34 	CTS - 36 	CTS - 38 	CTS - 48 
CTS - 50 	CTS - 52 			











## 5) Steel to Lug / Tape Connections Thermit Welding Joints (SLTC)

SLTC - 1 	SLTC - 2 	SLTC - 3 	SLTC - 4 	SLTC - 5 
SLTC - 6 	SLTC - 7 	SLTC - 8 	SLTC - 9 	SLTC - 11 
SLTC - 12 	SLTC - 13 	SLTC - 14 	SLTC - 15 	SLTC - 16 
SLTC - 17 	SLTC - 18 	SLTC - 19 	SLTC - 20 	







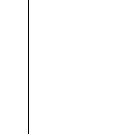











## 6) Steel to Rod / Stud Connections (SRSC)

SRSC - 1 	SRSC - 2 	SRSC - 5 	SRSC - 6 	SRSC - 7 
SRSC - 8 	SRSC - 9 	SRSC - 11 	SRSC - 23 	

## 7) Ground Rod to Ground Rod Connections Thermit Welding Powder Joints (GRGR)

GRGR – 1 	GRGR – 2 	GRGR – 3 	GRGR – 4 	GRGR – 5 
GRGR – 6 	GRGR – 7 	GRGR – 13 	GRGR – 14 	GRGR – 15 
GRGR – 16 				

## 8) Ground Rod to Tape Connections Thermit Welding Powder Joints (GRTC)

GRTC – 1 	GRTC – 2 	GRTC – 3 	GRTC – 4 	GRTC – 5 
GRTC – 6 	GRTC – 7 	GRTC – 8 	GRTC – 9 	GRTC – 11 
GRTC – 12 	GRTC – 13 	GRTC – 14 	GRTC – 15 	GRTC – 16 
GRTC – 17 	GRTC – 18 	GRTC – 19 	GRTC – 25 	

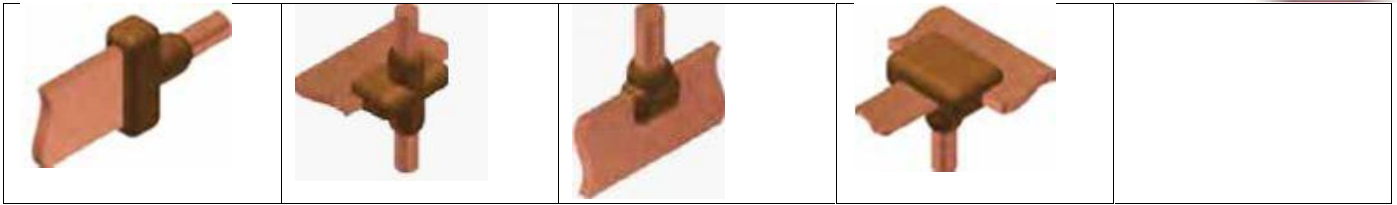













### 9) Cable to Re-Bar Connection Thermite Welding Powder Joints (CREC)

CREC - 1 	CREC - 2 	CREC - 3 	CREC - 4 	CREC - 
CREC - 6 	CREC - 7 	CREC - 8 	CREC - 9 	CREC - 11 
CREC - 12 	CREC - 13 	CREC - 14 	CREC - 15 	CREC - 16 
CREC - 17 	CREC - 18 	CREC - 19 	CREC - 20 	CREC - 21 
CREC - 25 	CREC - 35 	CREC - 36 	CREC - 38 	CREC - 48 
CREC - 51 	CREC - 52 			



## 10) Tape to Re-Bar Connection Thermit Welding Powder Joints (TREC)

TREC - 3 	TREC - 4 	TREC - 5 	TREC - 6 	TREC - 7 
TREC - 8 	TREC - 13 	TREC - 15 	TREC - 16 	TREC - 17 
TREC - 18 	TREC - 20 			

## 11) Re-Bar to Re-Bar Connection Thermit Welding Powder Joints (RERE)

RERE - 3 	RERE - 4 	RERE - 5 	RERE - 6 
--	---	---	--

## 12) Rod to Re-Bar Connection Thermit Welding Powder Joints (RORE)

RORE - 1 	RORE - 16 
--	--



### 13) Tape to Tape Connection Thermit Welding Powder Joints (TTC)

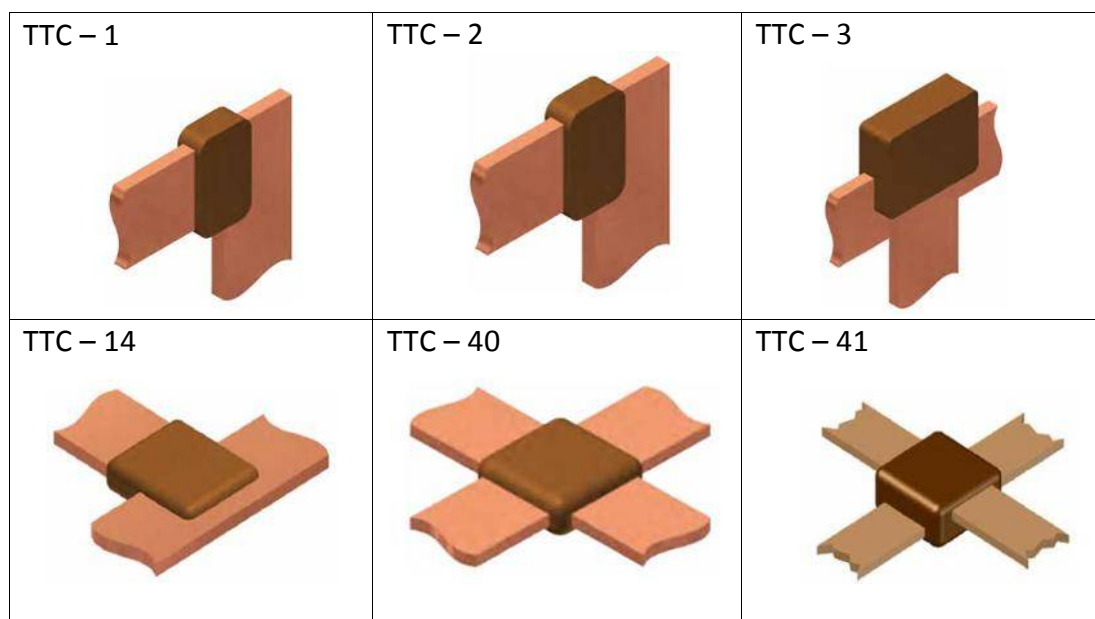

As referred by the Image, one can imagine that our Thermit Welding Powder can joint Copper Cable to Copper Cable in any Shape. The following shape possibilities are as below:

- 1) Horizontal Joint Thermit Welding of Copper Cable to Copper Cable Connection
- 2) Vertical Joint Thermit Welding of Copper Cable to Copper Cable Connection
- 3) Overlap Joint Thermit Welding of Copper Cable to Copper Cable Connection
- 4) Cross Joint Thermit Welding of Copper Cable to Copper Cable Connection
- 5) T Shape Joint Thermit Welding of Copper Cable to Copper Cable Connection
- 6) L Shape Joint Thermit Welding of Copper Cable to Copper Cable Connection
- 7) Y Shape Joint Thermit Welding of Copper Cable to Copper Cable Connection
- 8) Parallel Shape Joint Thermit Welding of Copper Cable to Copper Cable Connection etc.

As per the Customer Specification and Requirement any shape Joint is Possible by designing the Graphite Mould accordingly.



Amiable Impex is the only Company in India that offer Quality AiWeld Thermit Welding Powder at reasonable rate and ensures delivery within 10 to 15 days in India. Get high quality products at quickest lead time with fast response time. Get Full Customer Satisfaction. Our Products are tested and approved by CPRI Govt Body, Its also CE and ROHS Certified and we are also certified by ISO 9001:2008

We are the India's largest supplier or dealer in Thermit Welding Materials and offers a complete line of Thermit Welding Powder Solutions to meet the needs of every user.



**Amiable Impex**

understands your values

# AMIABLEIMPEX

Regd. Office -

**AMIABLE IMPEX.**

101-A / 501 -A, Surya Darshan, Pai Nagar,  
Borivali (W), Mumbai -400092. India.  
Phone: 022-28933996 / 022-28957101  
Fax: 022-28957102

**MAULIK SHAH**

Mob: + 91- 9594899995

E-mail: [info@exothermicweld.com](mailto:info@exothermicweld.com)  
[info@amiableimpex.com](mailto:info@amiableimpex.com)

**UJJWALSHAH**

Mob: + 91- 9820733979

Email: [ujjwal@amiableimpex.com](mailto:ujjwal@amiableimpex.com)

**Website:** [www.amiableimpex.com](http://www.amiableimpex.com)  
[www.exothermic-welding.com](http://www.exothermic-welding.com)  
[www.exothermicweldpowder.com](http://www.exothermicweldpowder.com)

